

DICHOPTIC BRIGHTNESS COMBINATION FOR UNEQUALLY COLOURED LIGHTS

CH. M. M. DE WEERT and W. J. M. LEVELT

Department of Psychology, University of Nijmegen, Erasmuslaan 16,
Nijmegen, The Netherlands

(Received 21 October 1975)

Abstract—In a series of experiments the brightness impressions of dichoptic mixtures of variable amounts of stimuli of different wavelength, have been matched against a binocular presented comparison stimulus of constant spectral composition. Test and comparison stimuli were presented successively, at the same retinal location. The relative contributions of left and right eye stimuli to the dichoptic brightness impression are dependent upon the wavelengths, in such a way that middle-wavelength stimuli contribute a larger part than either lower or higher wavelength stimuli.

DICHOPTIC BRIGHTNESS COMBINATION FOR UNEQUALLY COLOURED LIGHTS

A number of studies deal with the problem of dichoptic brightness combinations for equally coloured lights. See Blake and Fox (1973) for a recent review. Very few data are available about dichoptic brightness combinations for unequally coloured lights. One of the few examples of such measurements can be found in the study of Thomas, Dimmick and Luria (1961), in which dichoptic colour mixtures were compared to monoptic mixtures of the same colour components. They reported that the dichoptic mixture could be matched in colour with appropriately chosen proportions of the same components in the monoptic comparison mixture, which was presented to both eyes ("binocularly") and secondly that the sum of the luminances of the comparison components had to be twice the sum of the luminances of the dichoptic test stimuli. Or to use their own terminology, summation of luminances should occur for unequally coloured lights, contrary to an averaging behaviour for equally coloured lights. From the work of Hoffman (1962) a somewhat similar conclusion could be drawn in view of his way of presenting the amounts of red and green necessary to match a standard yellow monoptically and dichoptically. In a study on dichoptic colour mixture (de Weert and Levelt, 1976), in which a method, more or less similar to that of Thomas *et al.* was used, the dichoptic mixture was also sometimes reported to be brighter than the binocularly presented monoptic mixture of the same components. In that study, though, the issue raised by Thomas *et al.* was not systematically pursued.

The study of dichoptic brightness combinations seems interesting in several respects. The results obtained in an earlier study (de Weert and Levelt, 1974), involving dichoptic colour mixing experiments, pointed to a very special wavelength dependent interaction process. The middle-wavelength stimuli turned out to be rather strongly colour dominant in mixtures with lower or higher wavelength stimuli. We will amply return to these findings in a later section. The question is raised whether this effect is typical not only for the colour interaction process, but for the

brightness combination process as well. To the extent that brightness and colour processes are really independent it would not necessarily be the case. But the rigid separation of brightness and colour processing cannot be entirely maintained, since the rediscovery of the strong dependency of the luminance-brightness relationship on spectral composition of the stimulus, and the possibly related failure of Abney's law (Guth, 1969, 1973), Padgham (1971), Kaiser (1971), and many others. Abney's law can only be maintained under special conditions: i.e. if luminances are defined and measured as flicker-luminance, or if luminances are measured according to the minimally distinctness of border method as introduced by Boynton and Kaiser (1968). It is clear that the concepts of luminance and brightness are not unequivocal. As to the interaction of brightness and colour processes, a number of models has been proposed (Guth, 1969, 1973; Wasserman, 1970). Proposed as a preliminary model, the model of Guth looks interesting because he presented a rather detailed description of several kinds of brightness, and, more importantly, their interrelation with colour signals. Although no explicit location of the interaction processes of achromatic and chromatic signals has been proposed, a central locus cannot be excluded *a priori*.

In this article we report a series of experiments on dichoptic brightness combination for differently coloured stimuli.

In the first experiment we measured equibrightness curves for pairs of equally and unequally coloured test stimuli. The heart of this measurement's approach, which was introduced by Levelt (1965), lies in the use of a binocularly presented comparison stimulus of constant brightness. For white light combinations Levelt found a linear relation between left and right eye luminances, necessary to match the brightness of the constant comparison stimulus. The slope of this function is indicative for the ratio of the contributions of left and right eye to the dichoptic brightness impression. The locally linear character of the binocular brightness combination process has also been confirmed in a completely different type of experiment, using paired comparison measurements (de Weert and Levelt, 1974). Since the interpretation of

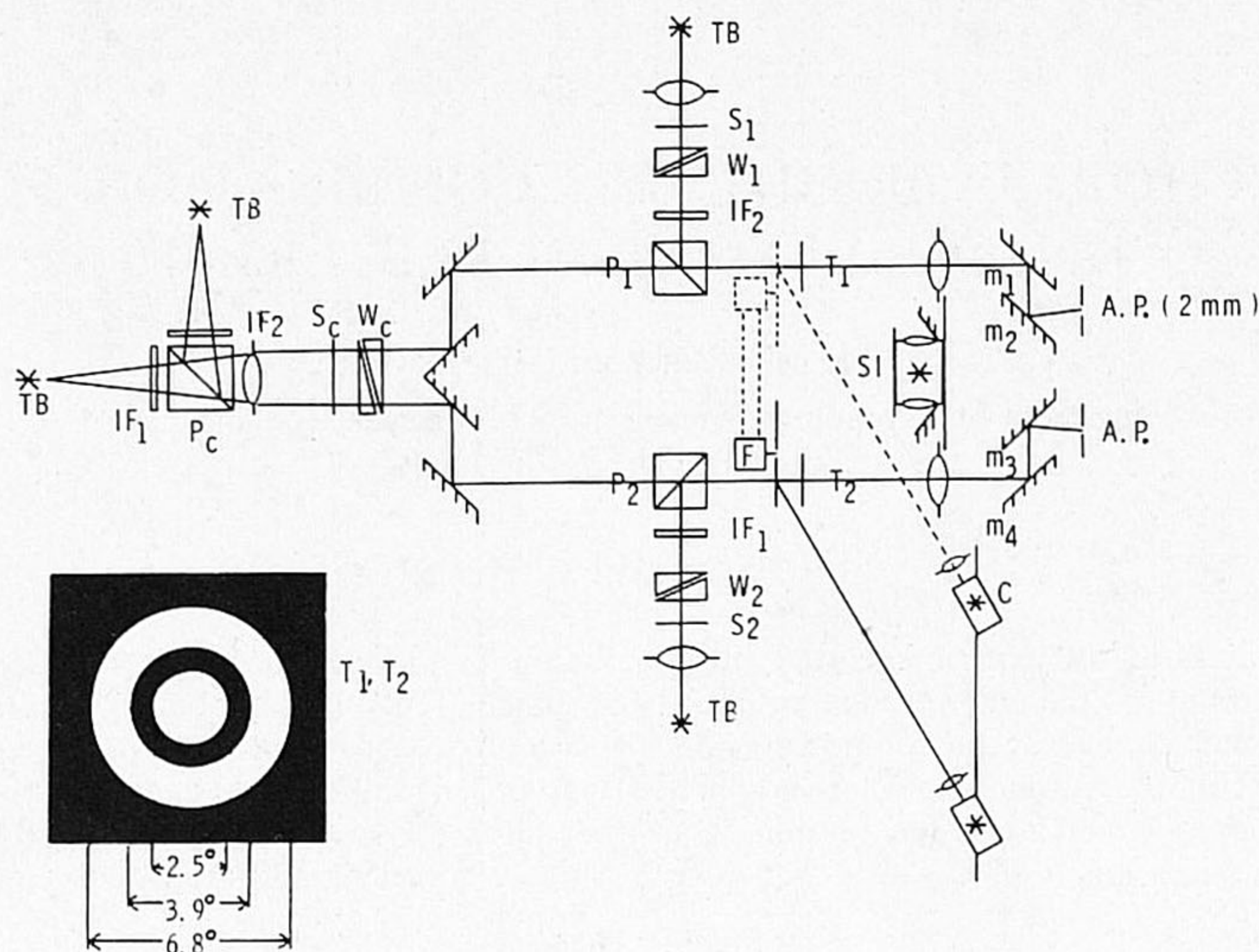

Fig. 1. Diagram of the optical equipment. TB: tungsten bandlamps; W_1 , W_2 and W_c : neutral density wedges; S_1 , S_2 and S_c : electromagnetic shutters; IF_1 , IF_2 : interference filters; P_1 , P_2 and P_c : beam-splitter prisms; T_1 , T_2 : test targets; SI: surround illumination light source; m_j : mirrors, forming the eye piece; C: calibration light source; F: flicker vane; A.P.: artificial pupils.

these initial results is strongly dependent upon the definition of brightness, i.e. in terms of flicker-photometry or in terms of direct comparison, further experiments were added to probe the dichoptic colour-brightness relation. In a second experiment the brightness impression of a number of dichoptic mixtures of equiluminous test stimuli (according to the CCFF method) of equal and of different wavelengths is measured in terms of the luminance of a comparison stimulus of constant spectral composition. This kind of measurement is extended to the dichoptic combinations of stimuli of different relative luminances. Analysis of the last type of data is used to compute the weighting factors for the differently coloured stimuli in the dichoptic combination.

APPARATUS

In Fig. 1 a diagram of the optical equipment is presented. Tungsten filament lamps, the current of which can be controlled, are used as light sources. Narrow band interference filters (Schott, type IL) provide monochromatic beams. The left and right test beams of wavelengths λ_i and λ_j pass through compensated circular neutral density wedges, which can be controlled manually at the observer's position. The test beams are reflected in beamsplitter prisms P_1 and P_2 and pass through the test targets T_1 and T_2 . The targets are seen in Maxwellian view through 2 mm circular artificial pupils. The system of mirrors, m_1 , m_2 , m_3 and m_4 , can be adjusted for each subject in order to accommodate the optical system to the subject's eye distance.

The comparison stimulus consists of two components identical in wavelength to the test stimuli, or chosen as complementaries to form a white stimulus. This choice depends upon the particular experiment. The two beams are combined in P_c and pass through wedge W_c before being split into two identical beams which pass through P_1 and P_2 and subsequently follow the same path as the test beams do. These optical pathways can simply be altered such that test beams and comparison beams are

presented above each other, as is necessary in simultaneous comparisons.

Electromagnetic shutters S_1 , S_2 and S_c are placed in the three beams. The targets are made of door-plate material, araldite. The white ring, obtained by milling the upper black layer away, leaving the lower white layer intact, is illuminated from the front side by a 50-W halogen lamp, the intensity of which can be controlled.

Luminances of test and comparison components are always adjusted by each subject individually by means of a flicker photometric comparison against a constant white patch of light, which is projected on a flicker vane. The system of flicker vane and calibration light can be moved from the left to the right eye position. The luminance level is chosen at 300 td. We prefer this method of luminance adjustment, because of the fact that luminance determined in this way corresponds to the definition of luminance by the C.I.E.

SUBJECTS

One or both of two subjects, S and W, having normal vision and normal colour vision, participated in all experiments to be reported. Both observers also served in dichoptic colour mixing experiments, which revealed the absence of strong eye dominance factors.

EXPERIMENT 1. EQUIBRIGHTNESS MEASUREMENTS

General procedure

A binocularly presented comparison stimulus of constant luminance is alternated in time with a dichoptic pair of test stimuli. The luminance of one of the test stimuli is set at different luminance values, and the subject's task is to adjust the luminance of the other test stimulus in such a way that a brightness match occurs between the dichoptic pair and the comparison pair. This method of measurement has been successfully used by Levelt (1965) for white light combinations.

Experimental conditions

Test stimuli. For the left eye-right eye test stimuli the pairs 554-627, 627-554, 521-584, 521-521, 584-554, 554-584 and 627-627 nm were chosen.

Comparison stimuli. The comparison stimulus consisted of two components, 609 and 493 nm, mixed in such proportions as to give a white. The luminance of the constant comparison stimulus corresponded to a retinal illumination of 300 td. For the 521-521 nm pair and for the 627-627 nm pair we used 521 and 627 nm respectively as comparison wavelengths, in order to see whether it was more the dichoptic combination process than the heterochromatic character of the matches which caused the uncertainty in the measurements. The choice of a whitish comparison stimulus may not seem directly obvious. Several reasons, however, can be adduced for the choice of a comparison stimulus of some constant spectral composition. The main reason lies in the lack of additivity of luminances for differently coloured lights, as has been convincingly shown by Guth (1969). If we took the same wavelength components for the test and the comparison stimuli, just as we did in a study on dichoptic colour mixing, the brightness impression of the binocularly presented monoptic mixture would be dependent upon the ratio of the comparison components. Also, there is an additional problem. If full brightness and colour matches must be made, the subjects have to make two adjustments at a time, which turns out to be rather difficult.

Presentation time. Test stimuli were presented for 500 msec, followed by a 500 msec pause, after which the comparison stimulus was presented for 500 msec. This cycle was repeated after another 500 msec. During the pause the stimuli kept fused by the steadily illuminated surrounding ring of low luminance.

Experimental procedure

Left and right eye test stimuli were equated in luminance against a constant calibration light by way of the CCF method. For the wedges in left and right test channels, the positions for a number of relative luminance values were determined, varying from 0.1 to 2 times the originally calibrated luminance value, which we call the "1" value. After making both test stimuli equal in flicker luminance to the standard, the luminance of the comparison stimulus was adjusted such as to obtain a heterochromatic brightness match to the (1,1) stimulus. (1,1) means: "1" stimuli in left and right eye. The determination of the equivalent white comparison luminance for the (1,1) stimulus must be performed with much care, because this value was then kept constant throughout subsequent experiments. After this calibration procedure, the luminance of the right eye test stimulus was brought at one of the predetermined levels and the subject's task was to adjust the left eye test luminance until a brightness match was reached between test and comparison. In general, 4-5 stimulation cycles were necessary for a measurement. Each measurement was repeated at least 5 times. The order of measurements was randomly chosen. For a number of combinations the whole procedure was reversed in that the left eye test stimulus was fixed by the experimenter, and the right eye value was adjusted by the observer.

Results

In Figs. 2, 3, 4 and 5, the resulting equibrightness functions are given for subject W. Adjustment of the red (627 nm) stimulus in the 554-627, and the 627-554 nm combinations turned out to be much more difficult than adjustment of the 554 nm one. The slopes of the 554-627 nm and the 627-554 nm equibrightness functions clearly deviate from -1, the value of the slope which would be expected if both eyes contributed equally to the dichoptic brightness impression.

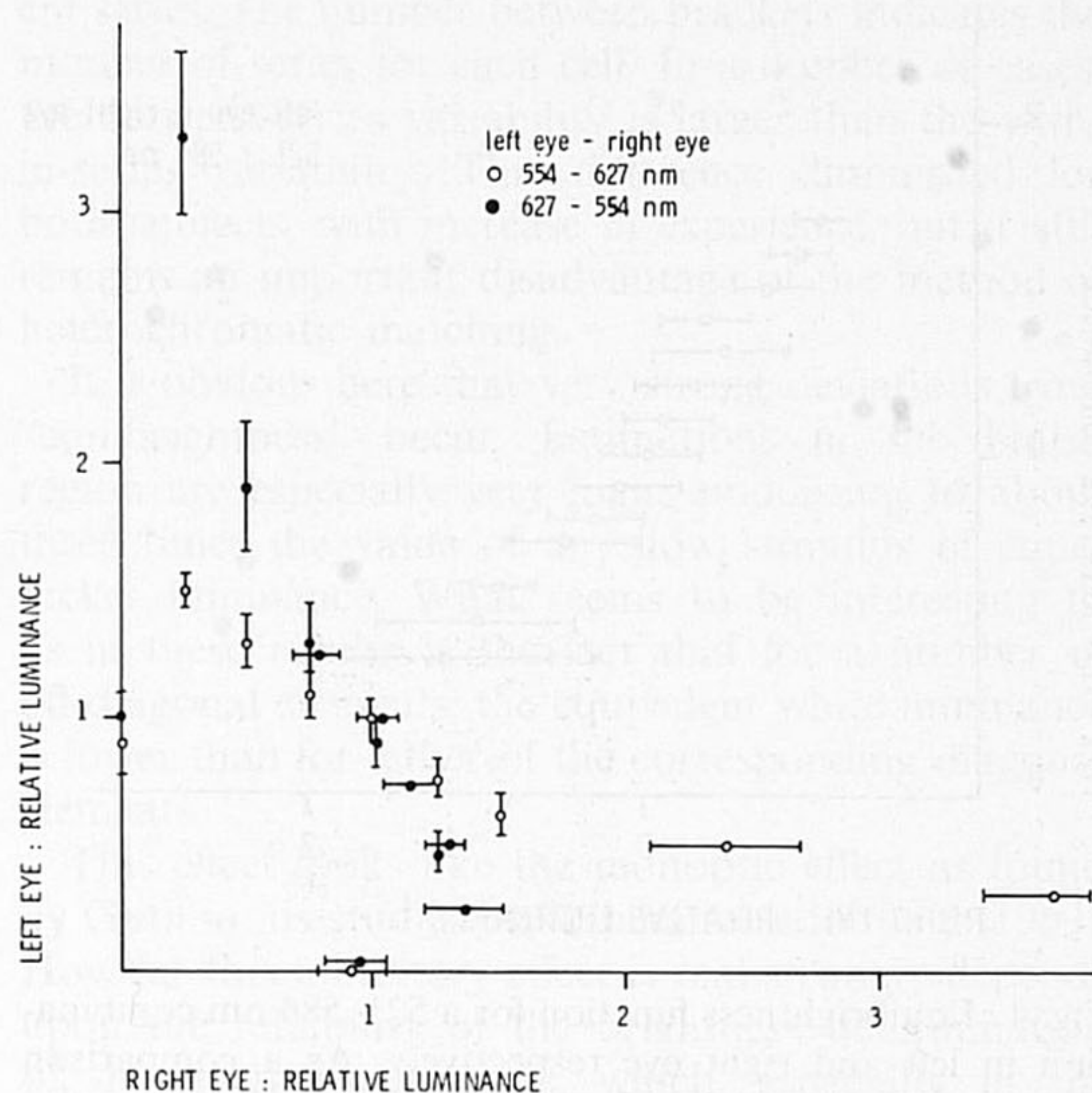

Fig. 2. Equibrightness functions for a 554-627 nm combination in left and right eye and for 627-554 nm. As a comparison stimulus a white light of constant brightness was used.

Much more intensity of the 627 nm stimulus is required to restore the brightness match when the 554 nm stimulus is halved in luminance, than of the 554 nm one when the 627 nm stimulus is halved. The slopes for the 521-584 nm, 554-584, 521-521 and 627-627 nm functions are about -1. The last two pairs were "homochromatic" matches. Accuracy of these measurements does not differ much from that in the heterochromatic matches.

Discussion

The results strongly resemble those obtained by Levelt (1965) for white light combinations. He described these equibrightness functions with a simple linear relation between left and right eye luminances,

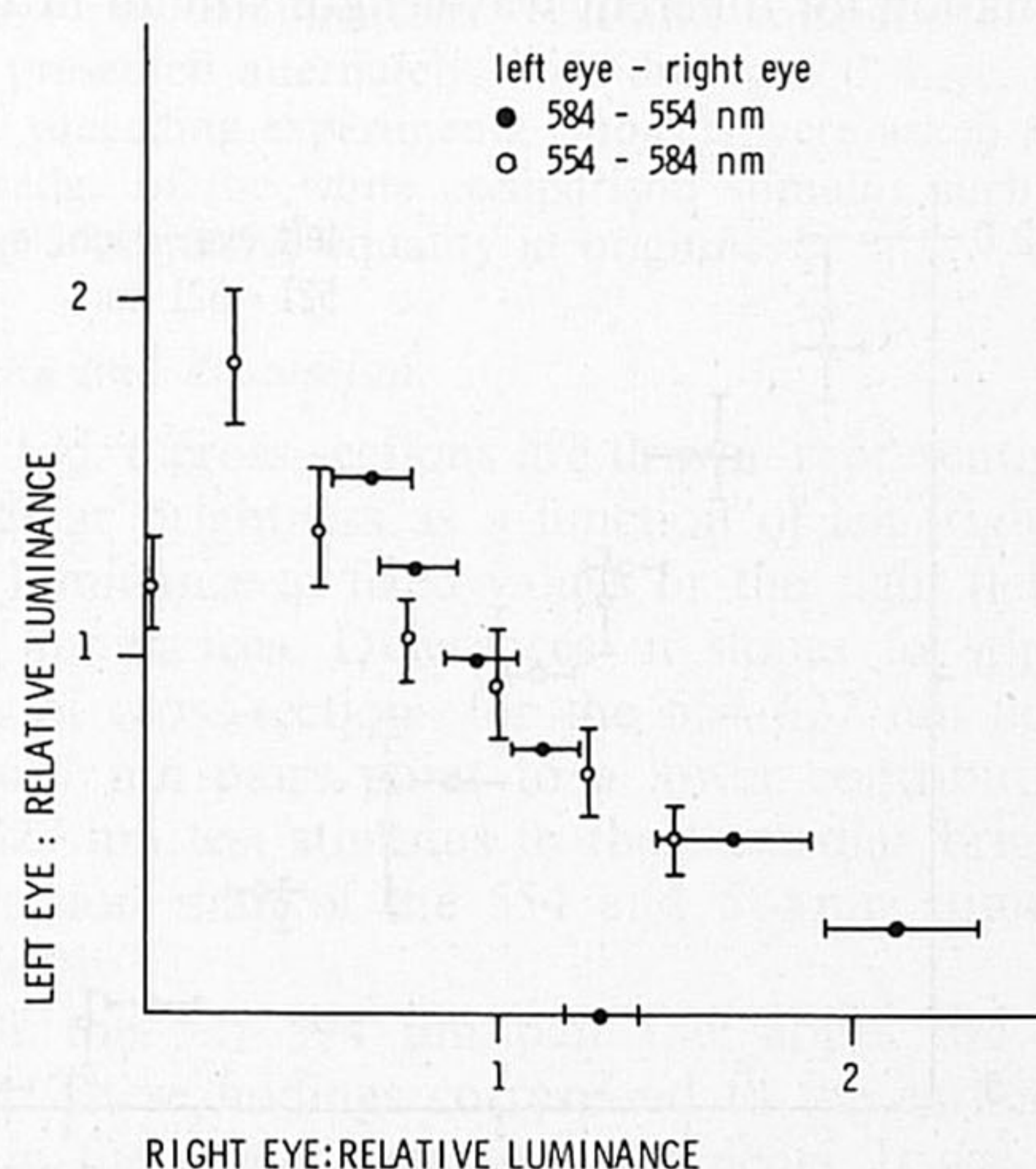

Fig. 3. Equibrightness functions for 554-584 nm and 584-554 nm stimulus combinations in left and right eye. A white comparison stimulus of constant brightness was used.

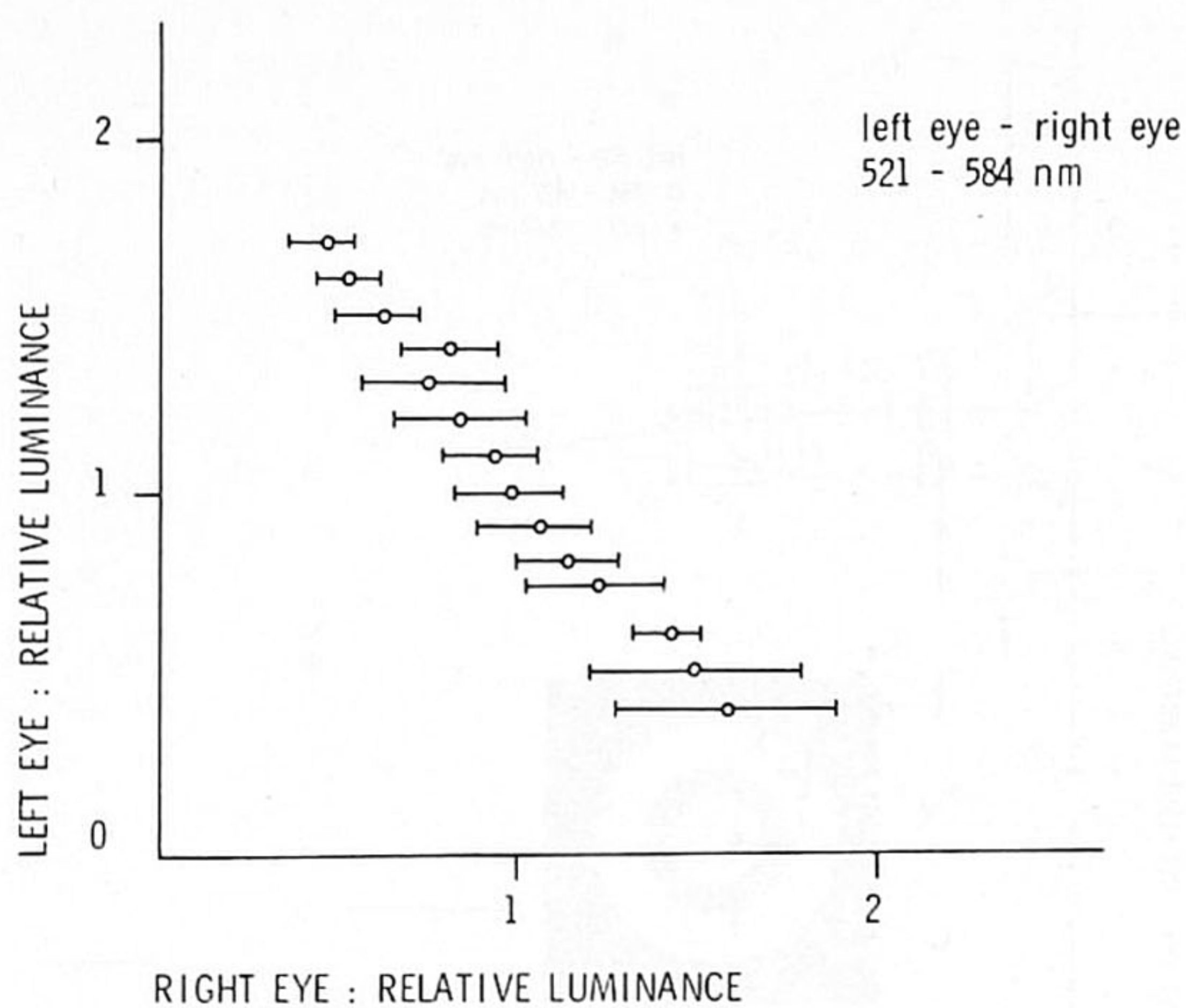

Fig. 4. Equibrightness function for a 521–584 nm combination in left and right eye respectively. As a comparison stimulus a white light of constant brightness was used.

for the middle range of luminances. Deviations from linearity, occurring at low luminance values, were ascribed to threshold effects. We will not go into this point here, but only mention that a number of mathematical formulations can be found, which describe both the linear and the nonlinear parts of the equibrightness functions (Engel, 1967, 1969; MacLeod, 1972; de Weert and Levelt, 1974).

For the case of differently coloured lights, however, we are faced with the problem of the effective value of the luminance for different λ . This issue will be dealt with in the next experiment.

EXPERIMENT 2. CALIBRATION OF FLICKER BRIGHTNESS ON DIRECT VIEWING BRIGHTNESS SCALES FOR STIMULI OF DIFFERENT COLOURS

In the preceding experiment, we mentioned the importance of the accurate determination of the (1,1) combination for different wavelength stimuli in terms

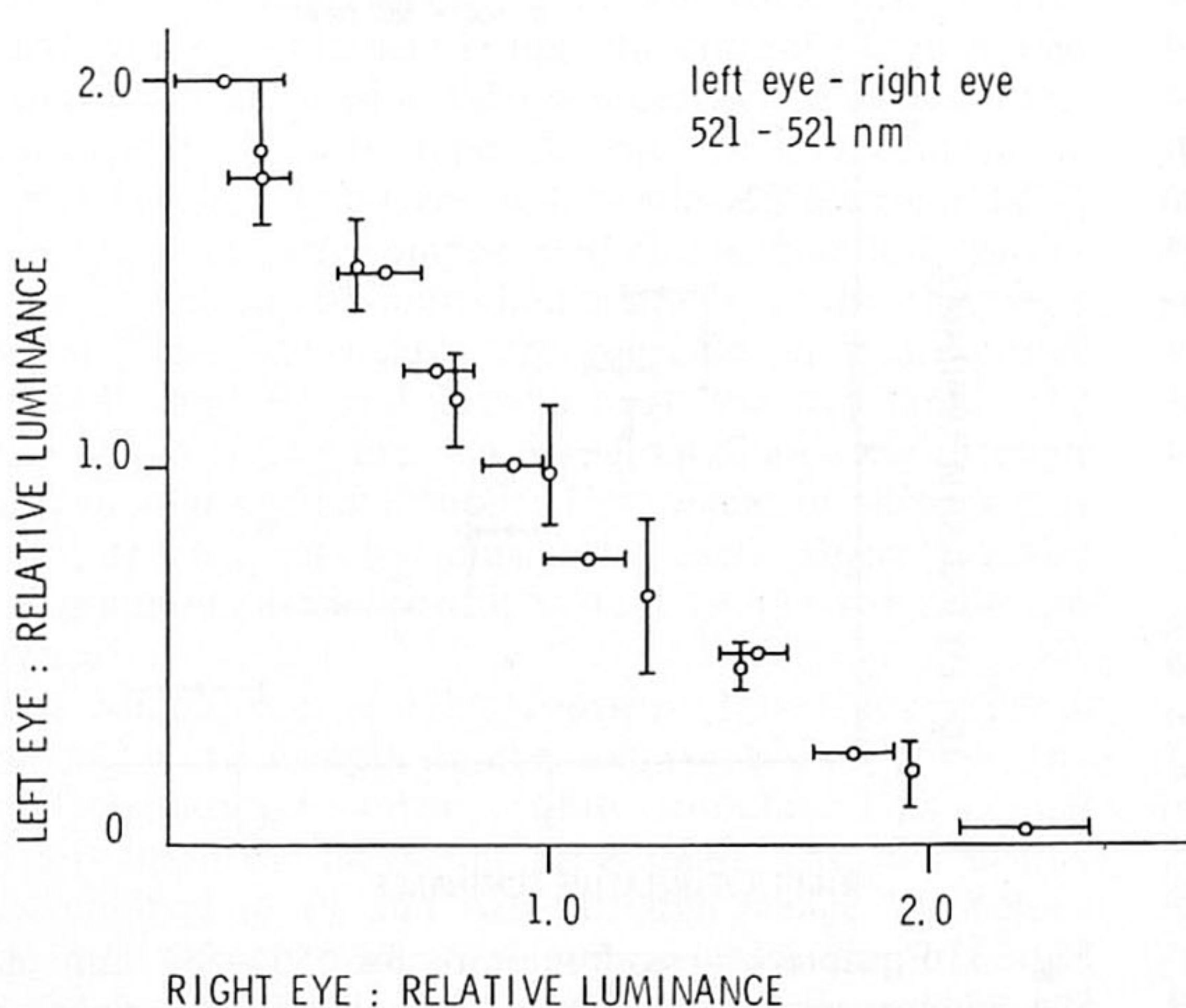

of luminance of the white comparison stimulus. Although we always started from equiluminous test stimuli, according to the CCF procedure, the (1,1) coloured combinations did not match in brightness with a white comparison stimulus, which was also flickered against the same standard. This is due to the fact that for unequally coloured lights, equality in flicker-defined luminance does not lead to equality in brightness, when judged in a non-flicker condition.

Only if luminance is defined in this special way or in the way proposed by Boynton and Kaiser (1968), where equality in luminance is reached when the contour between two adjacent fields is minimally discernible, is the classic Abney's law valid. As it makes no sense to use either a dichoptic minimally discernible border method, or a dichoptic flicker method, we will have to determine the equivalence of all (1,1) combinations in terms of the luminance value of the white comparisons stimulus, before we can compute the weighting factors in the equibrightness functions. This will be done in the next experiment.

Experiment 2.1: measurement of (1,1) combinations in terms of equivalent white luminances

In this experiment the luminances of the white comparison stimulus were determined, necessary to match the (1,1) combination for a number of pairs of different wavelengths.

Experimental procedure

All test stimuli were equated in luminance against the constant, 300 td, calibration light, by CCF, before the beginning of the experimental session. The following set of filters was used: 475, 498, 521, 554, 584, 594 and 627 nm.

The test stimuli were presented for 500 msec, followed by the white comparison stimulus for 500 msec, after a 500 msec pause. Subjects were supposed to turn the wedge (W_c) of the comparison stimulus such as to obtain an equality in brightness. The order of the (λ_i, λ_j) combinations to be measured was completely randomized. Each combination was measured six times.

Subjects. Two subjects, S and W, served in this series.

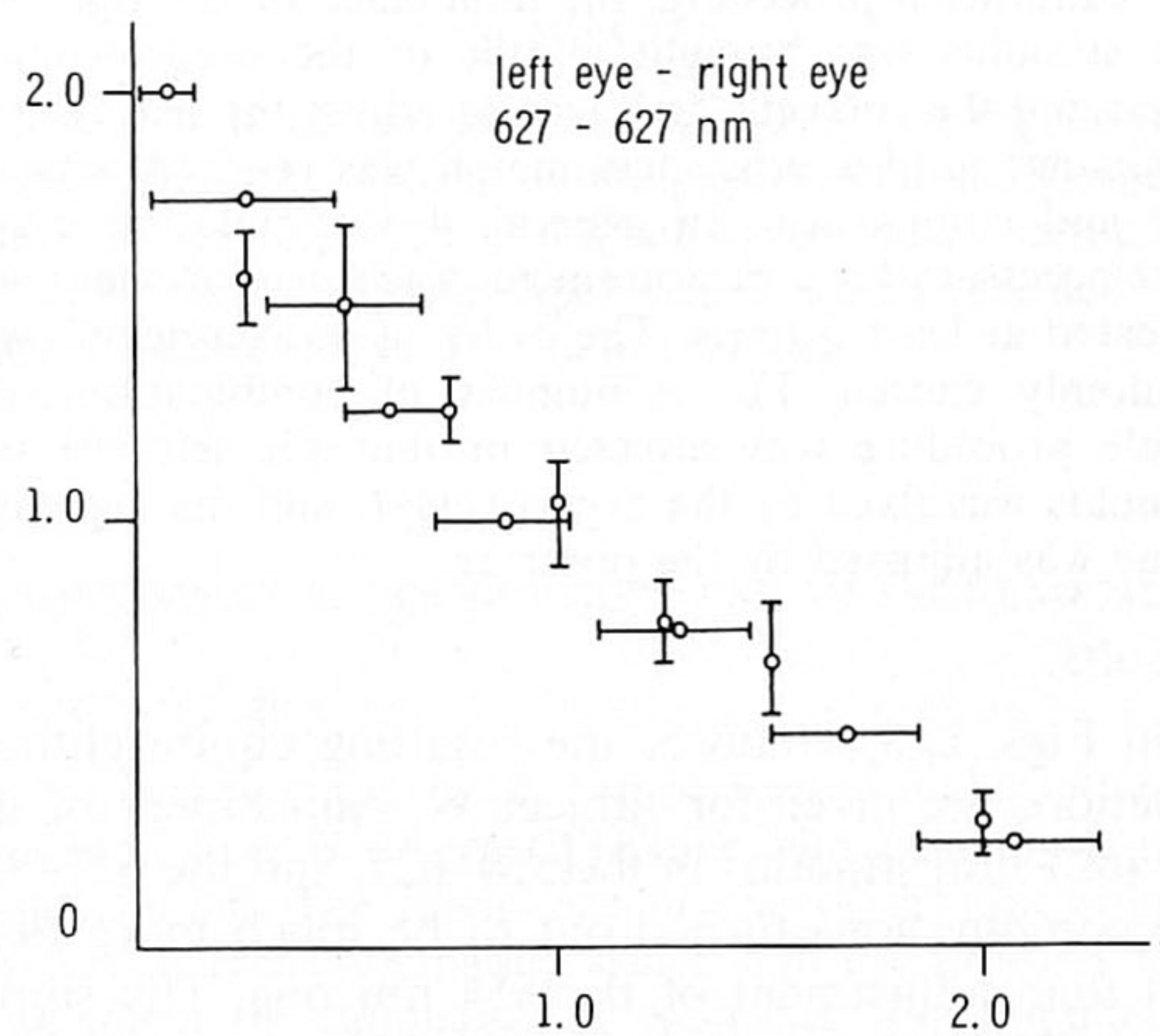

Fig. 5. Equibrightness functions for 521–521 nm and for 627–627 nm stimuli in left and right eye respectively. The colour of the comparison stimuli was the same as that of the test stimuli.

Table 1. Luminance values of a white comparison stimulus, necessary to match the brightness impression of a dichoptic mixture of equally luminous amounts of λ_i and λ_j stimuli in left and right eye respectively. The upper number in a cell represents the mean value of series, measured at different days. The number between brackets indicates the number of series. The middle number gives the mean value of the standard deviations of the separate series. The lower number represents the standard deviation for the mean of the different series. All values are normalized with respect to the 584–584 nm value

(nm)	Right eye stimuli (nm)						
	475	498	521	554	584	594	627
475	2.53	2.55	1.80	1.82	1.74	2.06	1.84
	0.23	0.28	0.09	0.18	0.10	0.19	0.14
498	2.28	1.87	1.52	1.46	1.34	1.46	1.51
	0.21	0.11	0.07	0.06	0.07	0.10	0.03
521	1.90	1.61	1.31 (4)	1.22 (4)	1.11 (4)	1.15 (4)	1.07 (4)
	0.10	0.10	0.08	0.07	0.07	0.08	0.09
554	1.50	1.46	1.17 (4)	1.19 (5)	1.08 (5)	1.04 (5)	0.92 (5)
	0.13	0.04	0.06	0.07	0.07	0.07	0.07
584	1.68	1.37	1.06 (4)	1.04 (5)	1.00 (5)	0.99 (5)	1.01 (5)
	0.19	0.07	0.06	0.06	0.06	0.06	0.07
594	1.63	1.51	1.13 (4)	1.03 (5)	1.02 (5)	1.08 (5)	1.04 (5)
	0.19	0.06	0.07	0.07	0.05	0.06	0.06
627		1.78	0.96 (4)	0.86 (5)	0.89 (5)	1.02 (5)	1.13 (5)
		0.13	0.08	0.08	0.08	0.09	0.08
			0.17	0.11	0.10	0.09	0.11

Results

Tables 1 and 2 represent the data as obtained in several sessions. We made a number of repetitions because of the strongly felt uncertainty of this kind of brightness matching. This uncertainty is usually not reflected in the data within one series. An explanation for this might be that subjects have problems in finding a criterion, but once the criterion is accepted, they are able to maintain it. The between-series variability is large. In the tables we indicate the mean values of different series, measured at different days, the mean standard deviation within series, and the standard deviation of the mean of the differ-

Table 2. See legend of Table 1, subject S

(nm)	Right eye stimuli (nm)						
	475	498	521	554	584	594	627
475	2.79 (2)	1.96	1.78	2.20	1.71	1.58	1.85 (2)
	0.43	0.31	0.31	0.20	0.42	0.38	0.10
498	2.12	1.48 (2)	1.07	1.00	0.79	1.06	0.77 (2)
	0.24	0.14	0.16	0.07	0.12	0.10	0.09
521	1.66	1.08	1.32 (4)	1.19 (2)	0.85 (2)	0.84 (2)	1.04 (3)
	0.19	0.10	0.13	0.15	0.16	0.12	0.14
554	1.98	1.34	0.96 (2)	1.00 (5)	0.79 (3)	0.78 (3)	0.74 (4)
	0.22	0.14	0.09	0.13	0.12	0.11	0.10
584	1.34	0.88	0.89 (2)	0.82 (3)	0.75 (4)	0.75 (3)	0.61 (4)
	0.18	0.16	0.08	0.11	0.10	0.11	0.11
594	1.70	1.04	0.82 (2)	0.69 (3)	0.75 (3)	0.76 (5)	0.59 (4)
	0.45	0.12	0.11	0.11	0.11	0.12	0.09
627	1.74	0.95 (2)	0.73 (3)	0.64 (4)	0.56 (4)	0.67 (4)	0.81 (5)
	0.22	0.13	0.09	0.08	0.07	0.10	0.15
	0.13	0.34	0.10	0.05	0.03	0.20	0.29

ent series. The number between brackets indicates the number of series for each cell. In a number of cases, the between-series variability is larger than the within-series variability. This difference diminished for both subjects, with increase in experience, but it still remains an important disadvantage of the method of heterochromatic matching.

It is obvious here that very strong deviations from "equibrightness" occur. Estimations in the bluish region are especially very high, amounting to about three times the value of a yellow stimulus of equal flicker luminance. What seems to be interesting to us in these results is the fact that for a number of off-diagonal elements, the equivalent white luminance is lower than for either of the corresponding diagonal elements.

This effect looks like the monoptic effect as found by Guth in his studies on luminance additivity (1969). How far this inhibitory effect is real strongly depends upon the reliability of the brightness determination of the diagonal elements, which, especially in the reddish region, is not very high.

Although there seem to be strong indications for unequal contributions of the two components for a number of wavelength pairs to the dichoptic brightness impression, the relative contributions still cannot be derived from these (1,1) measurements only.

We therefore decided to introduce a variant on the earlier presented equibrightness measurements, by setting the test luminances fixed at several values and varying the comparison luminance until a brightness match occurs.

Experiment 2.2

Dichoptic combinations of differently coloured stimuli of unequal luminance, measured in terms of a variable white comparison stimulus.

Experimental procedure

Luminance settings of the test stimuli were varied in steps, indicated by the relative values 0.25; 0.50; 1.00; 1.50; and 2.00, with 1.00 corresponding to a 300 td level of retinal illumination.

As test stimuli we used the 554–627, 584–627 and 521–594 nm combinations. Test and comparison stimuli were presented alternately, each during 500 msec, just as in the preceding experiments. Subjects were asked to turn the wedge of the white comparison stimulus such as to obtain a subjective equality in brightness.

Results and discussion

In Fig. 6 cross-sections are drawn, representing the binocular brightness as a function of left (right) test field luminance at fixed values or the right (left) test field luminances. Differences in slopes for the two types of cross-sections for the 554–627 nm and the 584–627 nm pairs point to a lower contribution of the 627 nm test stimulus to the binocular brightness impression than of the 554 and 584 nm stimuli respectively.

For the 521–594 nm pair the slopes are about equal. These findings correspond to the earlier findings in the equibrightness experiments. It was much easier, however, to adjust the comparison stimulus, than to adjust the test stimulus such as to obtain a brightness match. As long as we restrict the measurements to a small range of luminances around

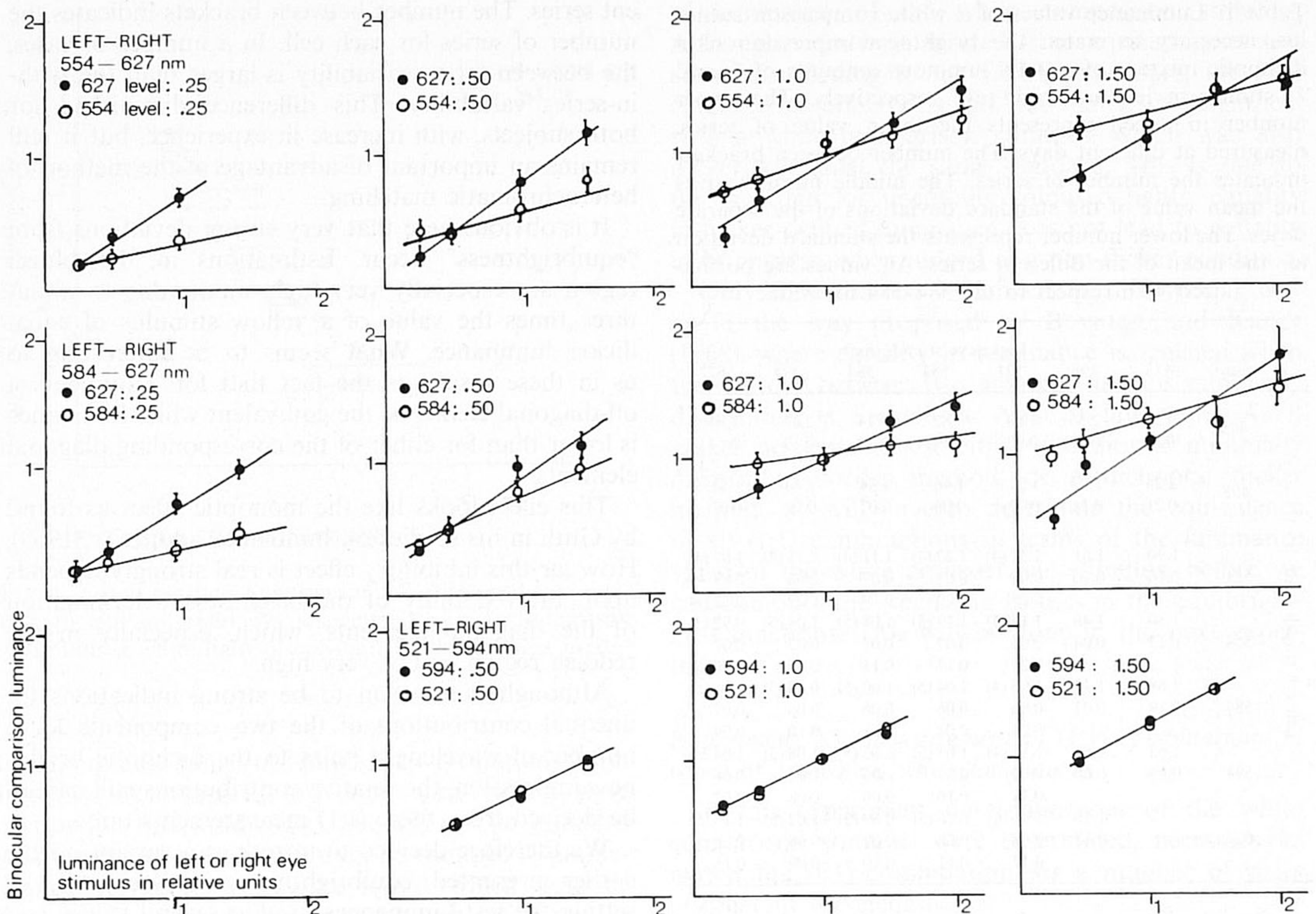

Fig. 6. Luminance values of a binocularly presented white comparison stimulus, necessary to match the brightness impression of dichoptic combinations of different amounts of λ_i and λ_j stimuli in left and right eye. Lines through open symbols represent the growth of the comparison luminance with growing intensity of the right eye stimulus, at fixed levels of the left eye stimulus. Lines through closed symbols represent the binocular comparison luminance as a function of the left eye luminance at fixed levels of the right eye stimulus.

the (1,1) point, we can describe the results with linear functions. Therefore we decided to restrict the number of luminance levels in the next experiment, in which a larger number of wavelength combinations was measured. These measurements will be used to compute the weighting factors for brightness as a function of the specific (λ_i, λ_j) combination.

Experiment 2.3. (1,1), (1, $\frac{1}{2}$) and ($\frac{1}{2}$, 1) measurements

In the preceding 500 msec test-500 msec comparison measurements, there might have been an influence of the test stimulus upon the comparison luminance. In order to improve the independency of the comparison brightness values, we decided to lengthen the duration of the comparison stimulus to 3 sec. One more reason to do this is that we would like to prevent strong colour adaptation effects in the test stimuli. A relatively long white comparison stimulus might at least partly restore the neutral adaptation, and furthermore bring the binocular system into equilibrium again.

Stimulus range

For subject W all combinations from the following series were measured: 498, 521, 554, 584, 594, 627 nm. For subject S 498 nm was left out.

Experimental procedure

The same white (609 + 493 nm) comparison stimulus

was used, except that it was presented for 3 sec now. The pause between the 500 msec presentation of the tests and the 3 sec presentation of the comparison stimulus was reduced to 30 msec. For each pair of test stimuli three different matches were made: (a) The (1,1) pair was measured again, because of the altered presentation times; (b) The (1, $\frac{1}{2}$) combination was matched, the right eye test field being halved in luminance; (c) The ($\frac{1}{2}$, 1) combination was measured with the left eye test field halved in luminance. Each measurement was repeated at least 10 times. The order of measurements of the different wavelength combinations was randomized. For a number of wavelength pairs we also measured these combinations in a 500 msec (test)/30 msec (pause)/500 msec (comparison) condition, to see whether lengthening of the comparison stimulus had any effect.

Results

In Tables 3 and 4 the results are given for subjects S and W respectively. For W the (1,1) measurements were repeated after one week. These values are placed between brackets in the tables. A clear asymmetry can be seen in the (1, $\frac{1}{2}$) and ($\frac{1}{2}$, 1) values in a number of off-diagonal elements. This effect was equally obvious in the 500/500 msec condition as in the 500/3000 msec condition.

That no strong eye dominance effects occur for these two subjects can be seen in the diagonal elements, which show about equal values for the (1, $\frac{1}{2}$) and the ($\frac{1}{2}$, 1) combinations.

Table 3. Subject S. Luminance values of the white comparison-stimulus, necessary to match the dichoptic brightness impressions for three conditions of the λ_i and λ_j stimulus luminances in left and right eye.

(1, 1): luminances in both eyes equal to the standard (upper); (1, $\frac{1}{2}$): right eye stimulus halved in luminance (middle); ($\frac{1}{2}$, 1): left eye stimulus halved in luminance (lower)

	(nm)	Right eye				
		521	554	584	594	627
Left eye	521	1.20 ± 0.12	1.66 ± 0.40	1.02 ± 0.22	1.20 ± 0.18	1.04 ± 0.14
		0.92 ± 0.08	0.90 ± 0.14	0.76 ± 0.08	1.06 ± 0.16	0.76 ± 0.08
		0.98 ± 0.22	0.94 ± 0.18	0.60 ± 0.12	0.90 ± 0.10	0.56 ± 0.08
	554	1.32 ± 0.40	1.00 ± 0.08	0.94 ± 0.14	1.14 ± 0.12	1.12 ± 0.14
		1.28 ± 0.46	0.80 ± 0.14	0.72 ± 0.10	0.86 ± 0.10	1.02 ± 0.12
		0.80 ± 0.07	0.74 ± 0.10	0.74 ± 0.08	0.70 ± 0.08	0.58 ± 0.12
	584	1.08 ± 0.08	0.92 ± 0.16	0.94 ± 0.10	1.06 ± 0.22	0.90 ± 0.16
		0.76 ± 0.10	0.82 ± 0.10	0.72 ± 0.10	0.86 ± 0.20	0.92 ± 0.20
		0.78 ± 0.08	0.78 ± 0.06	0.84 ± 0.16	1.02 ± 0.16	0.70 ± 0.12
	594	1.20 ± 0.26	1.16 ± 0.16	1.22 ± 0.20	1.16 ± 0.26	1.38 ± 0.26
		0.92 ± 0.10	0.70 ± 0.10	0.90 ± 0.20	0.88 ± 0.28	1.00 ± 0.28
		1.14 ± 0.22	0.94 ± 0.14	0.88 ± 0.14	0.86 ± 0.22	0.90 ± 0.10
	627	1.26 ± 0.14	1.20 ± 0.12	1.00 ± 0.18	1.32 ± 0.22	1.64 ± 0.26
		0.82 ± 0.14	0.64 ± 0.04	0.64 ± 0.06	0.96 ± 0.14	1.10 ± 0.32
		0.92 ± 0.16	1.08 ± 0.14	0.98 ± 0.22	0.94 ± 0.26	1.22 ± 0.26

Analysis and discussion

In both the equibrightness experiments and the experiments with variable comparison luminances, strong wavelength dependent effects are found. The difference in slope for the red-green and green-green or red-red combinations and the asymmetries in the (1, $\frac{1}{2}$) and ($\frac{1}{2}$, 1) combinations cannot be ascribed to structural eye dominance factors, although these may play their part as well. The diagonal values in Tables 3 and 4 most truly indicate possible eye dominance effects.

In order to compute the weighting factors for the two eyes in any (λ_i , λ_j) combination we will make use of Levelt's "energy-averaging" rule, which states that, for a limited range of luminances, the dichoptic brightness combination process can be described as if luminance values of left and right eye stimuli are averaged. The validity of this rule has been confirmed in a number of studies for combinations of equally coloured lights (Engel, 1967, 1969; de Weert and

Levelt, 1974). According to this theory, the weighting factors, which add up to unity, are largely independent of the luminance values *per se*, but are mainly determined by the relative richness of contours and contrasts in the two stimuli.

Let $L(\lambda_i)$, indicate the "equivalent white luminance" for the "1" amount of stimulus λ_i and let $L_1(i, j)$, $L_2(i, j)$ and $L_3(i, j)$ be the measured white luminance for the (1, 1), (1, $\frac{1}{2}$) and ($\frac{1}{2}$, 1) combinations respectively of a (λ_i , λ_j) stimulus combination in the left and right eye. Application of the luminance averaging rule, now applied to equivalent luminances, leads to three equations for each triple of (λ_i , λ_j) measurements:

- (a) $W_L L(\lambda_i) + W_R L(\lambda_j) = L_1(i, j)$
- (b) $W_L L(\lambda_i) + \frac{1}{2} W_R L(\lambda_j) = L_2(i, j)$
- (c) $\frac{1}{2} W_L L(\lambda_i) + W_R L(\lambda_j) = L_3(i, j)$.

Actually $L_1(i, j)$, $L_2(i, j)$ and $L_3(i, j)$ should be read as: $W'_L L(i, j) + W'_R L(i, j) = (W'_L + W'_R) L(i, j) = L(i, j)$ because the sum of the weighting factors is assumed to be unity for the white comparison stimuli. From (a), (b) and (c), a simple relation can be derived, which relates the three $L(i, j)$ values: $3 L_1(i, j) = 2[(L_2(i, j) + L_3(i, j))]$. Although this condition of internal consistency is not completely fulfilled for all combination, deviations are not severe enough to reject this description. The equivalent luminance $L(\lambda_j)$ for a unit amount of a λ_i stimulus can be derived from the (1, 1) measurements of the diagonal (λ_i , λ_j) combinations.

The weighting factors were computed from the equations (a), (b) and (c) according to a least-square procedure. It is simple to derive that the optimal values of the $W_L(\lambda_i)$ and $W_R(\lambda_j)$ factors are given by:

$$W_L(\lambda_i) = \frac{L_1(i, j) + 5 L_2(i, j) - 3.5 L_3(i, j)}{4.25 L(\lambda_i)}$$

and

$$W_R(\lambda_j) = \frac{L_1(i, j) + 5 L_3(i, j) - 3.5 L_2(i, j)}{4.25 L(\lambda_j)}$$

In Table 5 the matrices of W_L and W_R values, corresponding to the (λ_i , λ_j) measurements are represented.

Table 4. Subject W. See legend of Table 3

	(nm)	Right eye					
		498	521	554	584	594	627
Left eye	498	1.52 ± 0.06 (1.57)	1.48 ± 0.10 (1.49)	1.31 ± 0.11 (1.22)	1.14 ± 0.09 (1.19)	1.32 ± 0.12 (1.42)	1.16 ± 0.07 (1.28)
		1.12 ± 0.06	1.01 ± 0.07	0.85 ± 0.04	0.97 ± 0.10	0.93 ± 0.05	0.91 ± 0.03
		1.18 ± 0.11	1.08 ± 0.07	1.14 ± 0.07	0.90 ± 0.05	1.16 ± 0.04	0.80 ± 0.07
	521		1.26 ± 0.06 (1.39)	1.08 ± 0.09 (1.16)	1.01 ± 0.05 (1.14)	1.17 ± 0.07 (1.22)	0.92 ± 0.06 (0.95)
			0.92 ± 0.06	0.79 ± 0.02	0.85 ± 0.04	0.97 ± 0.07	0.82 ± 0.07
			0.96 ± 0.07	0.94 ± 0.08	0.91 ± 0.06	0.86 ± 0.06	0.62 ± 0.04
	554	1.27 ± 0.08 (1.28)	1.04 ± 0.05 (1.18)	1.07 ± 0.07 (1.08)	0.99 ± 0.09 (1.04)		0.88 ± 0.02 (0.96)
		1.06 ± 0.06	0.91 ± 0.06	0.77 ± 0.02	0.78 ± 0.03		0.78 ± 0.02
		0.92 ± 0.06	0.87 ± 0.07	0.84 ± 0.06	0.77 ± 0.03		0.53 ± 0.04
	584	1.18 ± 0.05 (1.25)	0.97 ± 0.10 (1.12)	0.93 ± 0.02 (1.03)	1.00 ± 0.07 (1.00)	0.86 ± 0.07 (0.99)	0.89 ± 0.05 (0.96)
		1.06 ± 0.07	0.85 ± 0.03	0.72 ± 0.05	0.74 ± 0.03	0.73 ± 0.02	0.76 ± 0.03
		1.04 ± 0.05	0.87 ± 0.06	0.84 ± 0.04	0.76 ± 0.04	0.72 ± 0.05	0.56 ± 0.04
	594	1.28 ± 0.10 (1.31)	1.09 ± 0.11 (1.18)	0.95 ± 0.05 (1.06)	0.92 ± 0.03 (1.04)	1.10 ± 0.06 (1.11)	0.93 ± 0.05 (1.15)
		1.09 ± 0.06	0.74 ± 0.04	0.63 ± 0.03	0.71 ± 0.03	0.86 ± 0.02	0.81 ± 0.07
		1.12 ± 0.08	0.79 ± 0.07	0.86 ± 0.06	0.82 ± 0.03	0.90 ± 0.04	0.70 ± 0.07
627	1.31 ± 0.15 (1.25)	0.86 ± 0.03 (1.16)	0.91 ± 0.07 (0.95)	0.89 ± 0.05 (0.99)	0.96 ± 0.06 (1.05)	1.22 ± 0.13 (1.15)	
	0.89 ± 0.08	0.54 ± 0.03	0.50 ± 0.02	0.55 ± 0.02	0.68 ± 0.10	0.97 ± 0.06	
	1.20 ± 0.07	0.85 ± 0.06	0.84 ± 0.03	0.84 ± 0.04	0.86 ± 0.06	0.98 ± 0.03	

Table 5. Weighting coefficients for left and right eye contributions to the dichoptic brightness impression for combinations of stimuli of different wavelengths in the two eyes. Left and right number in each cell stand for W_L and W_R respectively

(a) Subject S

Left eye stimuli nm	(nm)	Right eye stimuli										
		521	554	584	594	627	584	594	627	584	594	627
521	0.46	0.56	0.56	0.75	0.53	0.34	0.66	0.40	0.56	0.17		
554	0.96	0.19	0.57	0.44	0.46	0.53	0.70	0.33	0.98	0.06		
584	0.54	0.46	0.57	0.46	0.40	0.65	0.45	0.64	0.76	0.17		
594	0.36	0.72	0.28	0.80	0.53	0.62	0.52	0.48	0.65	0.34		
627	0.31	0.59	0.09	1.02	0.11	0.91	0.41	0.54	0.41	0.56		

(b) Subject W

Left eye stimuli nm	(nm)	Right eye stimuli											
		498	521	554	584	594	627	554	584	594	627	554	584
498	0.46	0.55	0.42	0.62	0.24	0.88	0.41	0.53	0.29	0.82	0.46	0.40	
521	0.46	0.55	0.42	0.62	0.24	0.88	0.41	0.53	0.29	0.82	0.46	0.40	
554	0.74	0.33	0.57	0.42	0.43	0.57	0.49	0.50			0.65	0.17	
584	0.68	0.42	0.53	0.45	0.39	0.59	0.48	0.52	0.48	0.43	0.65	0.19	
594	0.60	0.48	0.44	0.47	0.24	0.68	0.36	0.62	0.48	0.55	0.56	0.34	
627	0.30	0.65	0.14	0.63	0.09	0.74	0.15	0.76	0.28	0.63	0.51	0.53	

For a number of (λ_i, λ_j) pairs the sum of the weighting factors turns out to be less than unity. This inhibitory effect can also be observed in the (1, 1) measurements of experiment 2.1, where some off-diagonal elements turned out to be smaller than either of the corre-

sponding diagonal elements. We must be careful, however, in the interpretation of this effect, because it is not equally obvious for both observers. The measure which is of most interest, however, is the ratio of the W_L and W_R values for the different (λ_i, λ_j) combinations, because in an earlier experiment on dichoptic colour mixing (de Weert and Levelt, 1976) a remarkable colour dominance effect was found for the middle wavelength stimuli in dichoptic mixtures with stimuli of lower or higher wavelength. A function $c'(\lambda)$ was determined such that the colour dominance in a (λ_i, λ_j) mixture could be described as $c'(\lambda_i)/c'(\lambda_j)$.

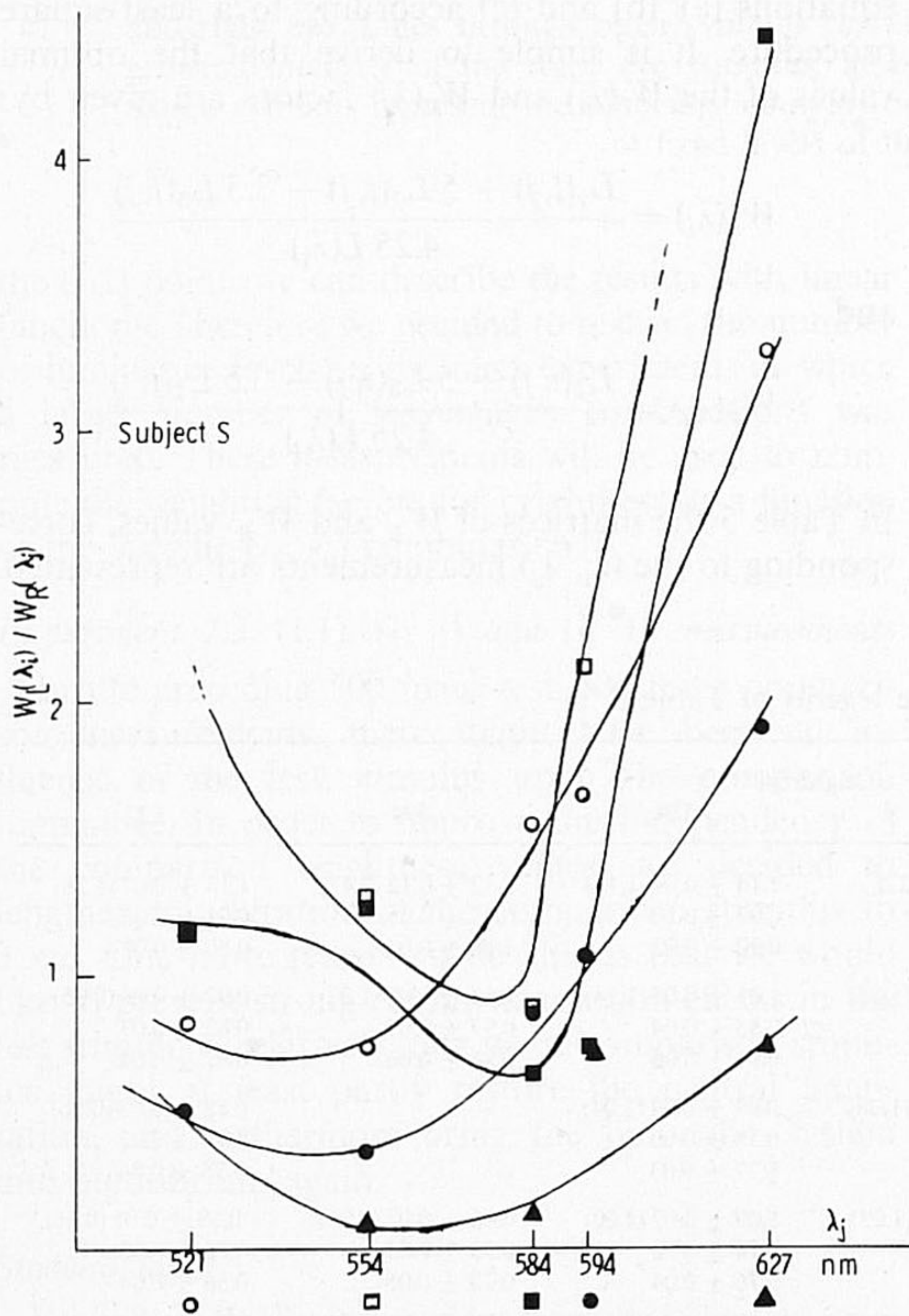

Fig. 7. Ratio of the weighting coefficients for left and right eye contributions to the dichoptic brightness impression, for combinations of stimuli of different wavelengths in the two eyes. Along the abscissa, λ_j values are represented. Symbols indicate the λ_i values.

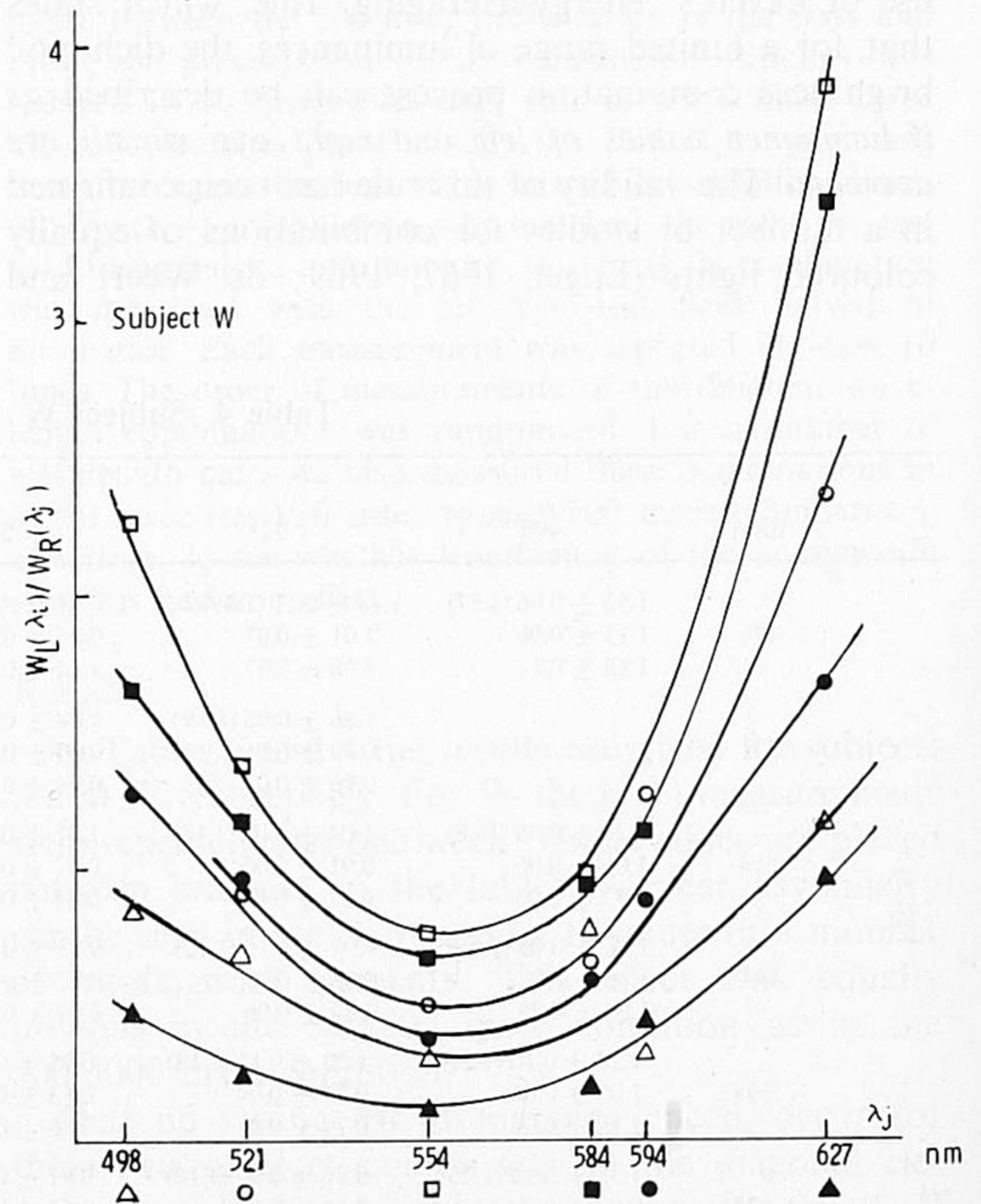

Fig. 8. See legend of Fig. 7.

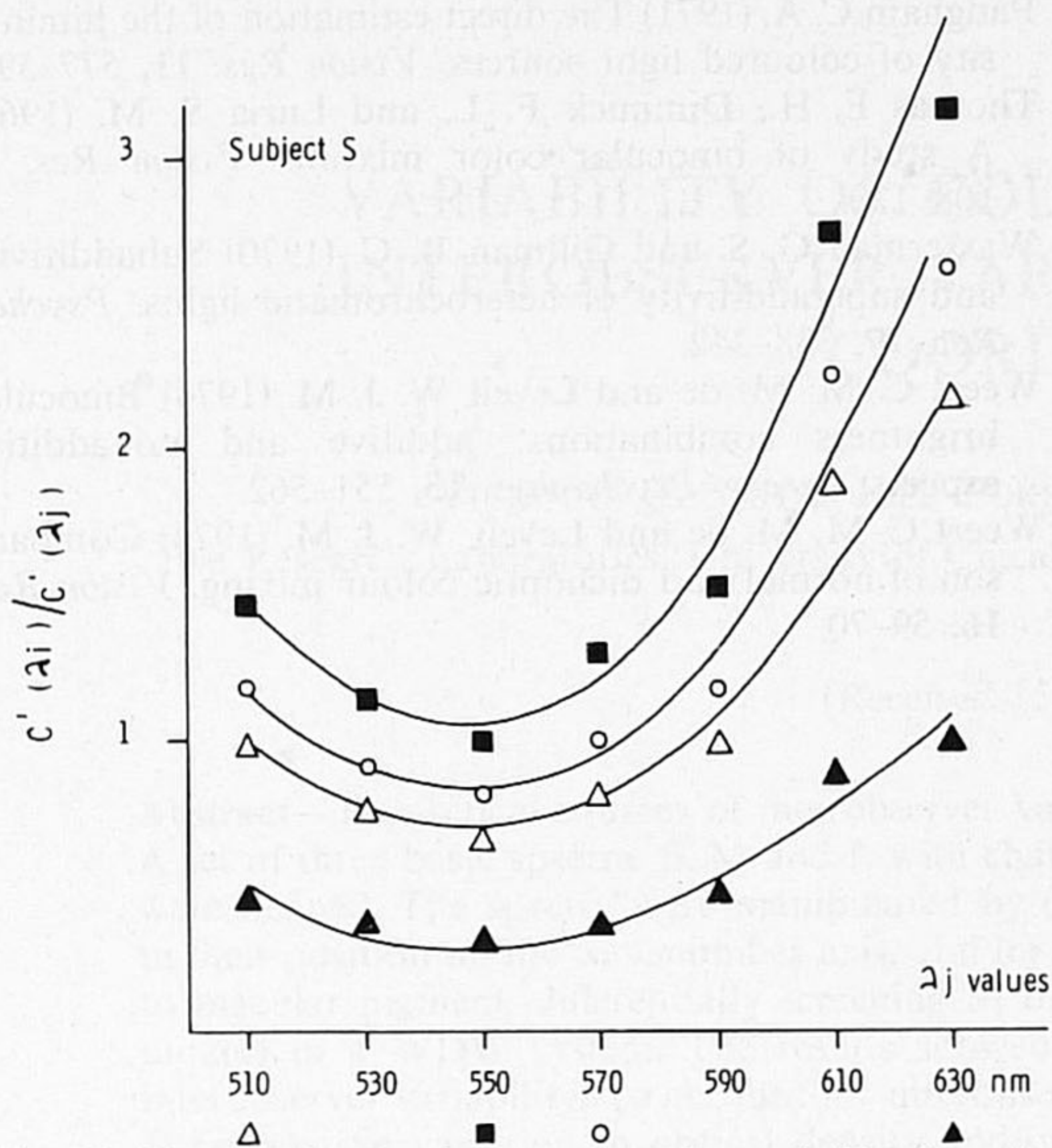

Fig. 9. Chromatic dominance functions, indicating the ratio of λ_i and λ_j components in a normal mixture, necessary to match the colour impression of a dichoptic mixture of equally luminous amounts of λ_i and λ_j stimuli, presented to the left and the right eye respectively.

In Figs. 9 and 10 these $c'(\lambda_i)/c'(\lambda_j)$ functions are shown. The resemblance to the $W_L(\lambda_i)/W_R(\lambda_j)$ functions, which are drawn in Figs. 7 and 8, is clear, despite the "noisiness" of the brightness data. Table 6 contains the squared values of the product moment correlations between the $c'(\lambda_i)/c'(\lambda_j)$ values, as obtained from dichoptic colour mixing experiments and the $W_L(\lambda_i):W_R(\lambda_j)$ values as computed for the brightness combination experiment. There is an obvious relation between the dichoptic brightness and colour dominance factors.

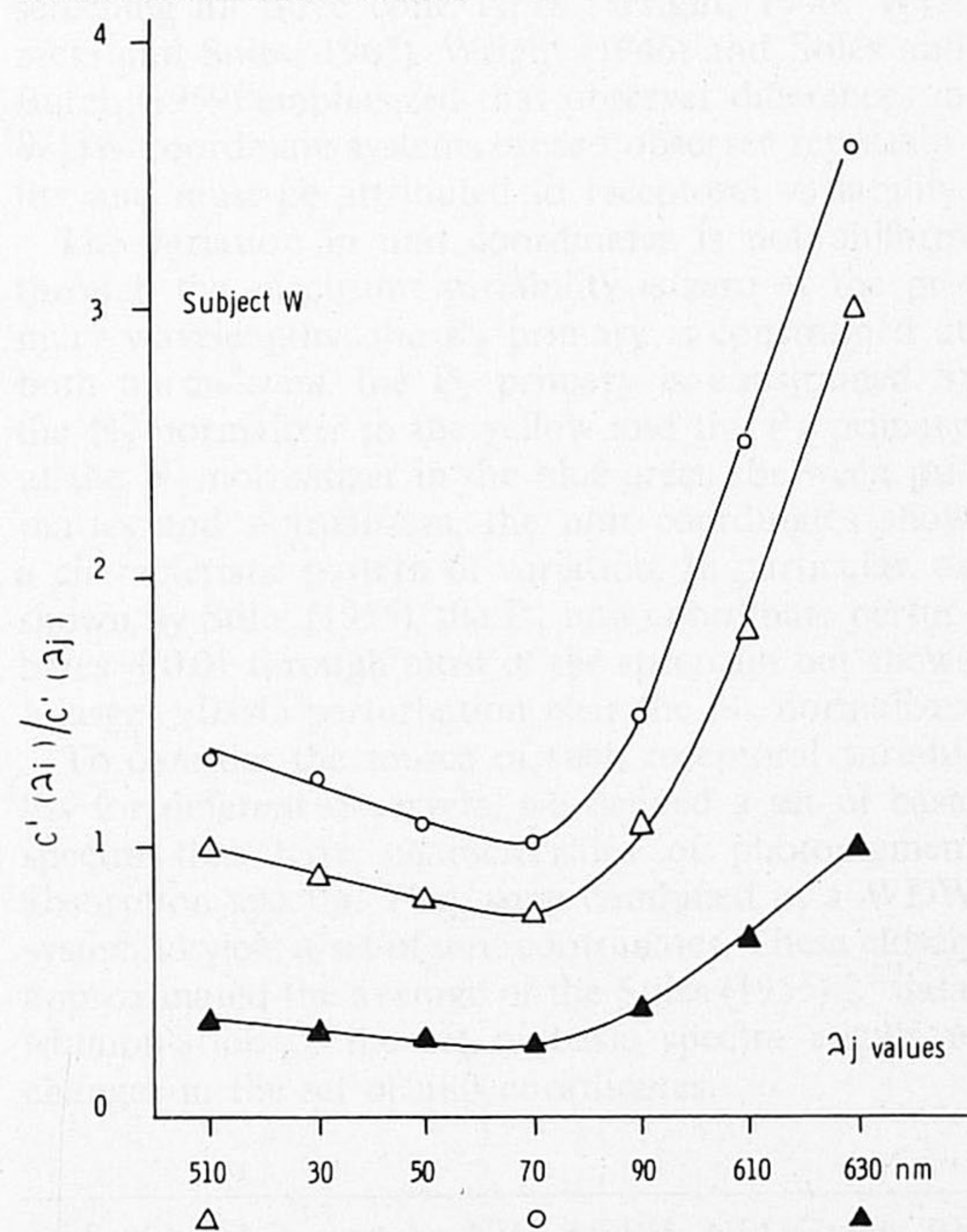

Fig. 10. See legend of Fig. 9.

Table 6. Squared values of the product moment correlations between $c'(\lambda_i)/c'(\lambda_j)$ and $w_1(\lambda_i)/w_r(\lambda_j)$ values for $\lambda_i < \lambda_j$ and for $\lambda_i > \lambda_j$ combinations in left and right eye

	W	S
$\lambda_i < \lambda_j$	$r^2 = 0.8934$ ($n = 14$)	$r^2 = 0.5613$ ($n = 10$)
$\lambda_i > \lambda_j$	$r^2 = 0.7814$ ($n = 14$)	$r^2 = 0.5944$ ($n = 10$)

Up till now we did not find any indication for the summative effect as reported by Thomas *et al.* (1961)—we rather found evidence to the contrary. We cannot, however, deny the existence of a kind of summation effect as found by Thomas *et al.*, because this effect was measured under somewhat different conditions, i.e. full colour and brightness matches were made, using the same colour components in test and comparison. It could be the case that non additivity effects as described by Guth (1969, 1973) have a greater impact in the comparison stimuli (where the colour components are mixed monocularly) than in the dichoptic combination. If so, however, we would not expect a constant summation factor, independent of the wavelength, as was reported by Thomas *et al.*

CONCLUSION

In conclusion it seems that there exists a strong relation between colour and brightness channels in dichoptic combination. For both, the effectiveness of a stimulus in dichoptic combinations is strongly wavelength dependent, the general rule being that the middle-wavelength stimuli are more effective than both lower and higher wavelengths. The explanation for this finding is not obvious. The relation between the $c'(\lambda_i)/c'(\lambda_j)$ and the $W(\lambda_i)/W(\lambda_j)$ values is the more striking where the $c'(\lambda_i)/c'(\lambda_j)$ functions were obtained from dichoptic mixtures of equiluminous spectral test stimuli, whereas the $W(\lambda_i)/W(\lambda_j)$ values were obtained from measurements in which luminance values were varied. Luminance, or brightness values *per se* are not the determinants of the stimulus dominance factors, at least not in our experimental conditions. A number of other experiments are necessary in order to find out which (common) aspect of the stimuli in a dichoptic mixture must be thought to be responsible for this wavelength dependent stimulus dominance behaviour.

REFERENCES

Blake R. and Fox R. (1973) The psychophysical inquiry into binocular summation. *Percept. Psychophys.* **14**, 161-185.
 Boynton R. M. and Kaiser P. K. (1968) The additivity law made to work for heterochromatic photometry with bipartite fields. *Science, N.Y.* **161**, 366-368.
 Engel G. R. (1967) The visual process underlying binocular brightness summation. *Vision Res.* **7**, 753-767.
 Engel G. R. (1969) The autocorrelation function and binocular brightness mixing. *Vision Res.* **9**, 1111-1130.
 Guth S. L., Donley N. J. and Marrocco R. T. (1969) On luminance additivity and related topics. *Vision Res.* **9**, 537-575.

Guth S. L. and Lodge H. R. (1973) Heterochromatic additivity, foveal spectral sensitivity and a new colour model. *J. opt. Soc. Am.* **63**, 450-462. Also in *Color Metrics* (Edited by Vos J. J., Friele L. F. C. and Walraven P. L.). AIC/Holland, Soesterberg (1972).

Hoffman C. S. (1962) Comparison of monocular and binocular color matching. *J. opt. Soc. Am.* **52**, 75-80.

Kaiser P. K. (1971) Minimally distinct border as a preferred psychophysical criterion in visual heterochromatic photometry. *J. opt. Soc. Am.* **61**, 966-971.

Levelt W. J. M. (1965) *On Binocular Rivalry*. Mouton, The Hague.

Macleod D. I. A. (1972) The Schrödinger equation in binocular brightness combination. *Perception* **1**, 321-324.

Padgham C. A. (1971) The direct estimation of the luminosity of coloured light sources. *Vision Res.* **11**, 577-590.

Thomas F. H., Dimmick F. L. and Luria S. M. (1961) A study of binocular color mixture. *Vision Res.* **1**, 108-120.

Wasserman G. S. and Gillman B. C. (1970) Subadditivity and superadditivity of heterochromatic lights. *Psychol. Rev.* **77**, 338-342.

Weert C. M. M. de and Levelt W. J. M. (1974) Binocular brightness combinations: additive and nonadditive aspects. *Percep. Psychophys.* **15**, 551-562.

Weert C. M. M. de and Levelt, W. J. M. (1976) Comparison of normal and dichoptic colour mixing. *Vision Res.* **16**, 59-70.

